



STP40NF10L

N-CHANNEL 100V - 0.028Ω - 40A TO-220 LOW GATE CHARGE STripFET™ POWER MOSFET

TYPE	V _{DSS}	R _{DS(on)}	I _D
STP40NF10L	100 V	< 0.033 Ω	40 A

- TYPICAL R_{DS(on)} = 0.028Ω
- EXCEPTIONAL dv/dt CAPABILITY
- 100% AVALANCHE TESTED
- APPLICATION ORIENTED CHARACTERIZATION

DESCRIPTION

This Power Mosfet series realized with STMicroelectronics unique STripFET process has specifically been designed to minimize input capacitance and gate charge. It is therefore suitable as primary switch in advanced high-efficiency isolated DC-DC converters for Telecom and Computer application. It is also intended for any application with low gate charge drive requirements.

APPLICATIONS

- HIGH-EFFICIENCY DC-DC CONVERTERS
- UPS AND MOTOR CONTROL
- AUTOMOTIVE

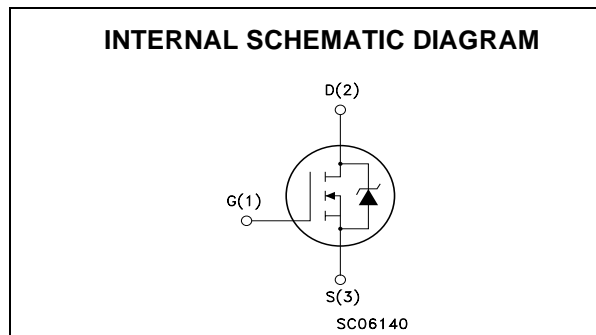
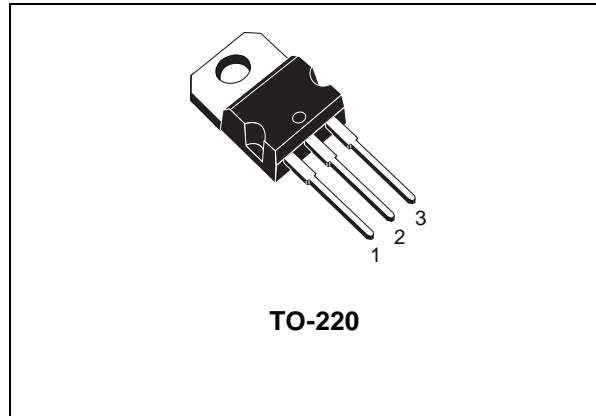

ABSOLUTE MAXIMUM RATINGS

Symbol	Parameter	Value	Unit
V _{DS}	Drain-source Voltage (V _{GS} = 0)	100	V
V _{DGR}	Drain-gate Voltage (R _{GS} = 20 kΩ)	100	V
V _{GS}	Gate- source Voltage	± 17	V
I _D	Drain Current (continuous) at T _C = 25°C	40	A
I _D	Drain Current (continuous) at T _C = 100°C	25	A
I _{DM} (●)	Drain Current (pulsed)	160	A
P _{TOT}	Total Dissipation at T _C = 25°C	150	W
	Derating Factor	1	W/°C
E _{AS} (1)	Single Pulse Avalanche Energy	430	mJ
T _{stg}	Storage Temperature	-65 to 175	°C
T _j	Max. Operating Junction Temperature	175	°C

(●) Pulse width limited by safe operating area

(1) Starting T_j = 25°C, I_D = 20A, V_{DD} = 40V

STP40NF10L

THERMAL DATA

Rthj-case	Thermal Resistance Junction-case Max	1	°C/W
Rthj-amb	Thermal Resistance Junction-ambient Max	62.5	°C/W
T _I	Maximum Lead Temperature For Soldering Purpose	300	°C

ELECTRICAL CHARACTERISTICS (TCASE = 25 °C UNLESS OTHERWISE SPECIFIED)

OFF

Symbol	Parameter	Test Conditions	Min.	Typ.	Max.	Unit
V _{(BR)DSS}	Drain-source Breakdown Voltage	I _D = 250 μA, V _{GS} = 0	100			V
I _{DSS}	Zero Gate Voltage Drain Current (V _{GS} = 0)	V _{DS} = Max Rating V _{DS} = Max Rating, T _C = 125 °C			1 10	μA μA
I _{GSS}	Gate-body Leakage Current (V _{DS} = 0)	V _{GS} = ± 17V			±100	nA

ON (1)

Symbol	Parameter	Test Conditions	Min.	Typ.	Max.	Unit
V _{GS(th)}	Gate Threshold Voltage	V _{DS} = V _{GS} , I _D = 250μA	1	1.7	2.5	V
R _{DS(on)}	Static Drain-source On Resistance	V _{GS} = 10V, I _D = 20 A V _{GS} = 5V, I _D = 20 A		0.028 0.030	0.033 0.036	Ω Ω

DYNAMIC

Symbol	Parameter	Test Conditions	Min.	Typ.	Max.	Unit
g _{fs} (1)	Forward Transconductance	V _{DS} = 15V, I _D = 20 A		25		S
C _{iss}	Input Capacitance	V _{DS} = 25V, f = 1 MHz, V _{GS} = 0		2300		pF
C _{oss}	Output Capacitance			290		pF
C _{rss}	Reverse Transfer Capacitance			125		pF

ELECTRICAL CHARACTERISTICS (CONTINUED)

SWITCHING ON

Symbol	Parameter	Test Conditions	Min.	Typ.	Max.	Unit
$t_{d(on)}$	Turn-on Delay Time	$V_{DD} = 50\text{ V}, I_D = 20\text{ A}$		25		ns
t_r	Rise Time	$R_G = 4.7\Omega, V_{GS} = 4.5\text{ V}$ (see test circuit, Figure 3)		82		ns
Q_g	Total Gate Charge	$V_{DD} = 80\text{ V}, I_D = 40\text{ A}, V_{GS} = 5\text{ V}$		46	64	nC
Q_{gs}	Gate-Source Charge			12		nC
Q_{gd}	Gate-Drain Charge			22		nC

SWITCHING OFF

Symbol	Parameter	Test Conditions	Min.	Typ.	Max.	Unit
$t_{d(off)}$	Turn-off-Delay Time	$V_{DD} = 50\text{ V}, I_D = 20\text{ A},$		64		ns
t_f	Fall Time	$R_G = 4.7\Omega, V_{GS} = 4.5\text{ V}$ (see test circuit, Figure 3)		24		ns
$t_{d(off)}$	Off-voltage Rise Time	$V_{clamp} = 80\text{ V}, I_D = 40\text{ A}$		51		ns
t_f	Fall Time	$R_G = 4.7\Omega, V_{GS} = 4.5\text{ V}$		29		ns
t_c	Cross-over Time	(see test circuit, Figure 3)		53		ns

SOURCE DRAIN DIODE

Symbol	Parameter	Test Conditions	Min.	Typ.	Max.	Unit
I_{SD}	Source-drain Current				40	A
$I_{SDM(1)}$	Source-drain Current (pulsed)				160	A
$V_{SD(2)}$	Forward On Voltage	$I_{SD} = 40\text{ A}, V_{GS} = 0$			1.3	V
t_{rr}	Reverse Recovery Time	$I_{SD} = 40\text{ A}, di/dt = 100\text{ A}/\mu\text{s},$		110		ns
Q_{rr}	Reverse Recovery Charge	$V_{DD} = 30\text{ V}, T_j = 150^\circ\text{C}$		467		nC
I_{RRM}	Reverse Recovery Current	(see test circuit, Figure 5)		8		A

Note: 1. Pulsed: Pulse duration = 300 μs , duty cycle 1.5 %.
 2. Pulse width limited by safe operating area.

Safe Operating Area

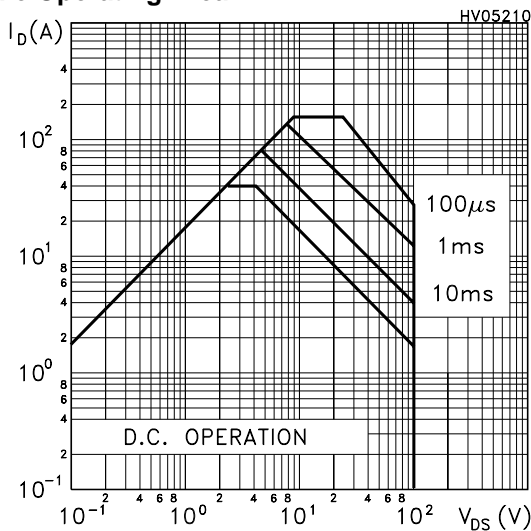

Thermal Impedance

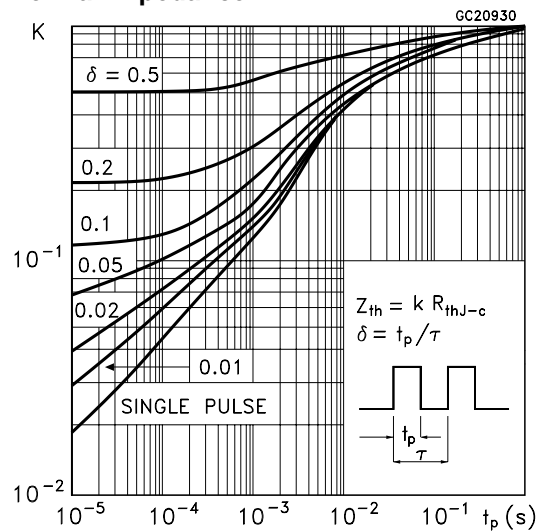

STP40NF10L

Output Characteristics

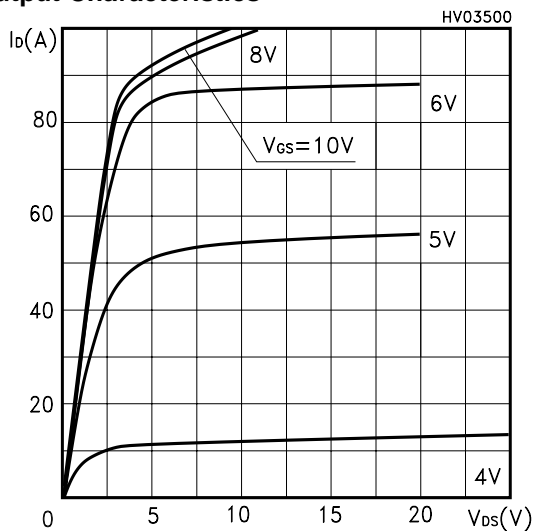

Transfer Characteristics

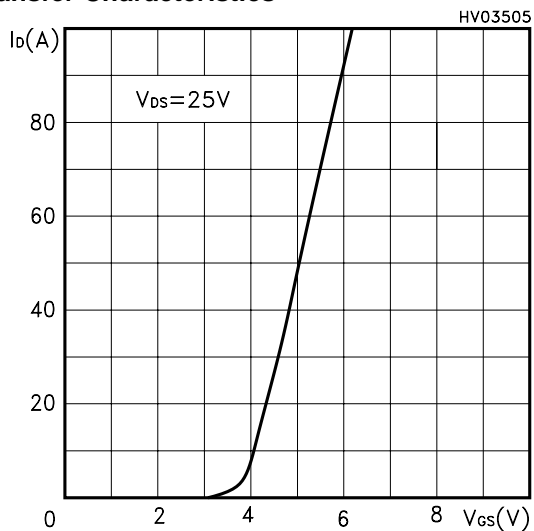

Transconductance

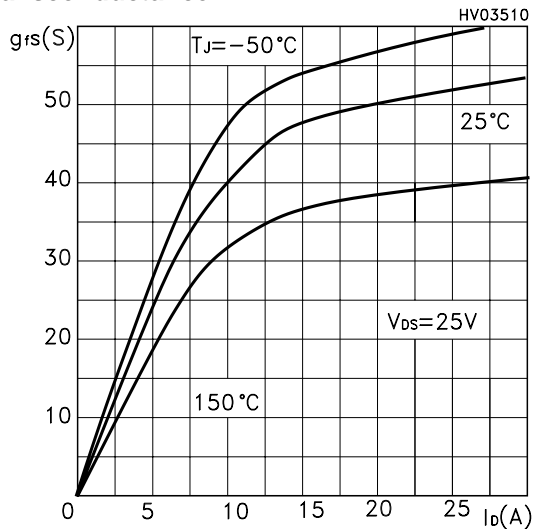

Static Drain-source On Resistance

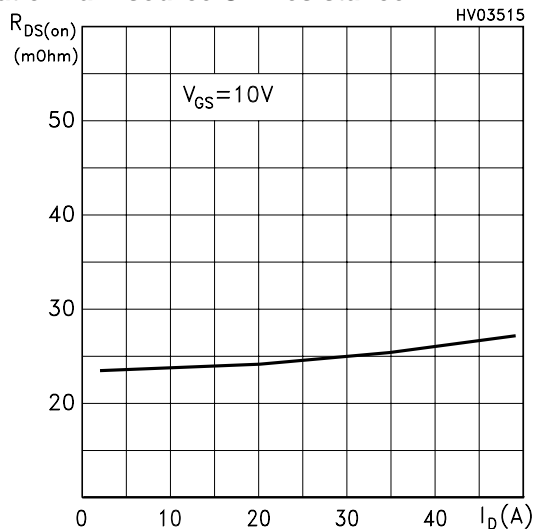

Gate Charge vs Gate-source Voltage

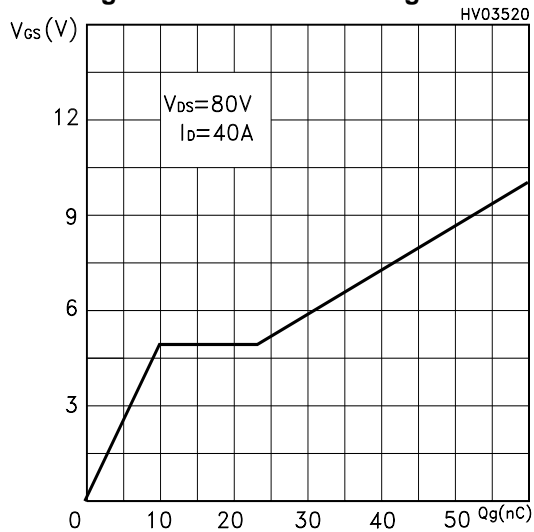

Capacitance Variations

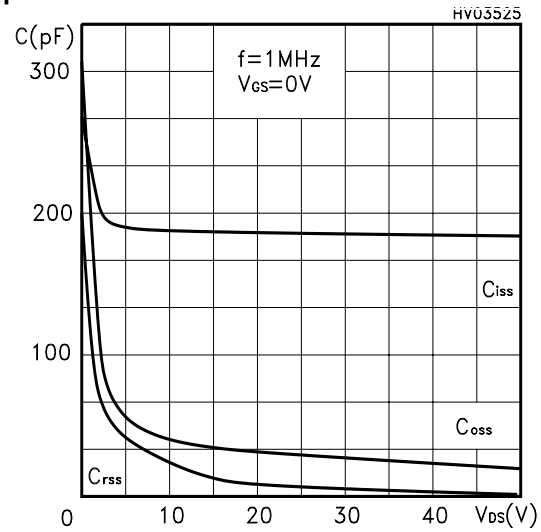

Normalized Gate Threshold Voltage vs Temperature

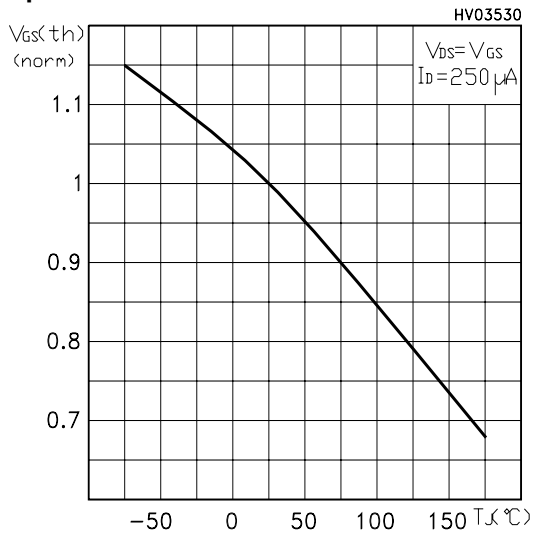

Normalized On Resistance vs Temperature

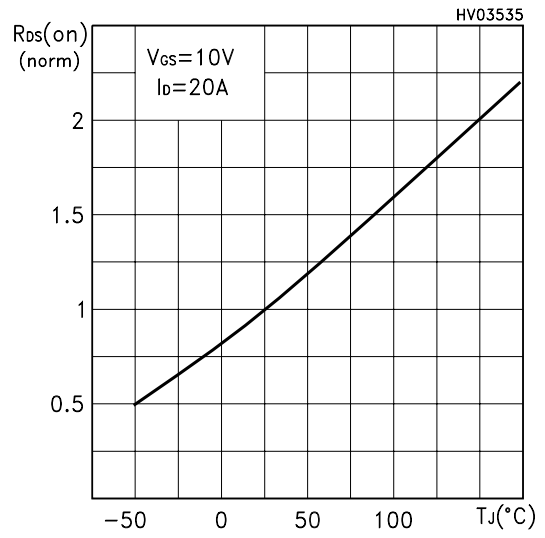

Source-drain Diode Forward Characteristics

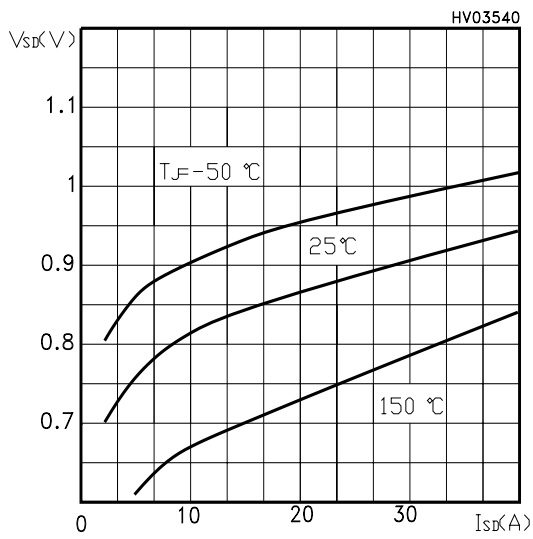

Normalized Drain-Source Breakdown vs Temperature

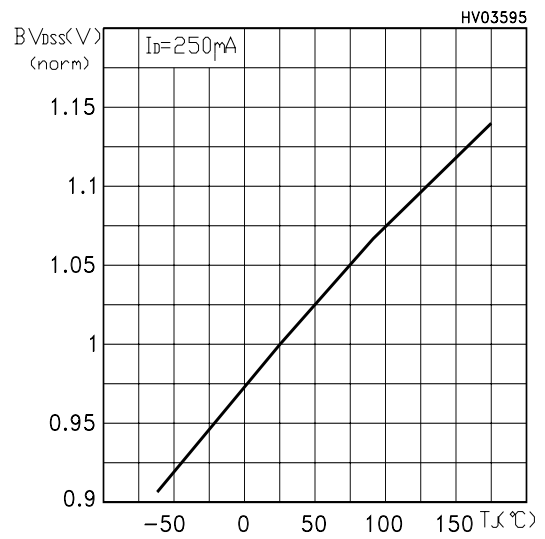

Fig. 1: Unclamped Inductive Load Test Circuit



Fig. 2: Unclamped Inductive Waveform



Fig. 3: Switching Times Test Circuit For Resistive Load



Fig. 4: Gate Charge test Circuit

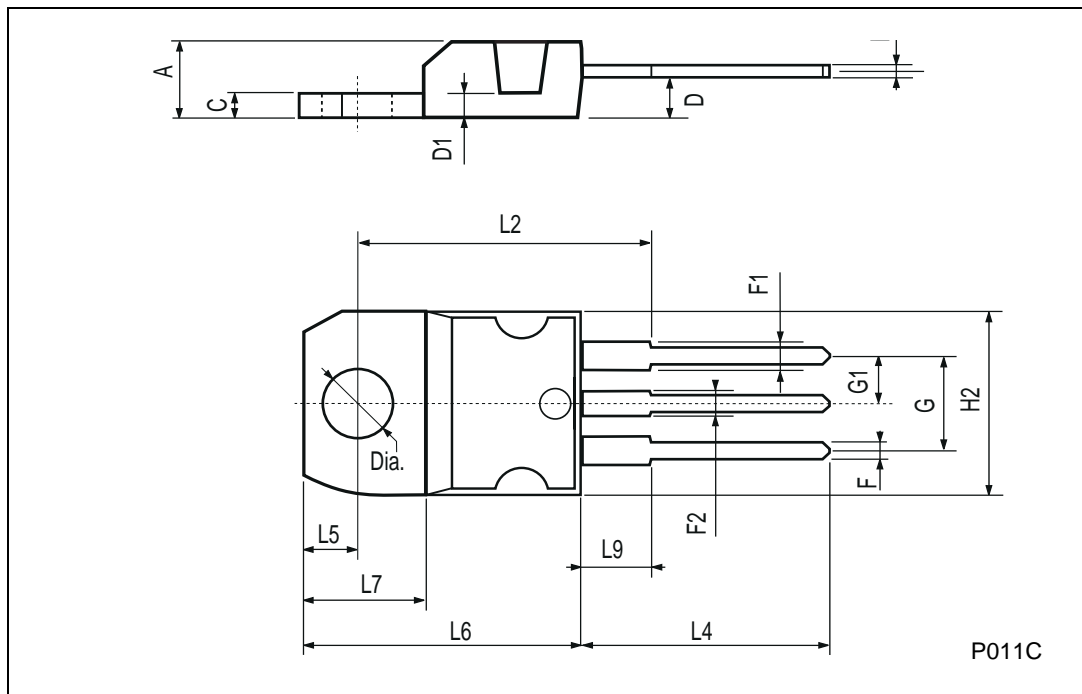

Fig. 5: Test Circuit For Inductive Load Switching And Diode Recovery Times



TO-220 MECHANICAL DATA

DIM.	mm			inch		
	MIN.	TYP.	MAX.	MIN.	TYP.	MAX.
A	4.40		4.60	0.173		0.181
C	1.23		1.32	0.048		0.051
D	2.40		2.72	0.094		0.107
D1		1.27			0.050	
E	0.49		0.70	0.019		0.027
F	0.61		0.88	0.024		0.034
F1	1.14		1.70	0.044		0.067
F2	1.14		1.70	0.044		0.067
G	4.95		5.15	0.194		0.203
G1	2.4		2.7	0.094		0.106
H2	10.0		10.40	0.393		0.409
L2		16.4			0.645	
L4	13.0		14.0	0.511		0.551
L5	2.65		2.95	0.104		0.116
L6	15.25		15.75	0.600		0.620
L7	6.2		6.6	0.244		0.260
L9	3.5		3.93	0.137		0.154
DIA.	3.75		3.85	0.147		0.151



Information furnished is believed to be accurate and reliable. However, STMicroelectronics assumes no responsibility for the consequences of use of such information nor for any infringement of patents or other rights of third parties which may result from its use. No license is granted by implication or otherwise under any patent or patent rights of STMicroelectronics. Specifications mentioned in this publication are subject to change without notice. This publication supersedes and replaces all information previously supplied. STMicroelectronics products are not authorized for use as critical components in life support devices or systems without express written approval of STMicroelectronics.

© The ST logo is a registered trademark of STMicroelectronics

© 2002 STMicroelectronics - Printed in Italy - All Rights Reserved
STMicroelectronics GROUP OF COMPANIES

Australia - Brazil - Canada - China - Finland - France - Germany - Hong Kong - India - Israel - Italy - Japan - Malaysia - Malta - Morocco
Singapore - Spain - Sweden - Switzerland - United Kingdom - United States.

© <http://www.st.com>